



Construction

Close-coupled centrifugal pumps; electric motor with extended shaft directly connected to the pump up to 30 kW, new bracket construction for standard motors (stub-shaft construction) from 37 to 75 kW with integrated thrust bearing.

Pump casing with axial suction and radial delivery on top, main dimensions and performance according to EN 733.

NM(S): version with pump casing and lantern bracket in cast iron.
B-NM(S): version with pump casing and lantern bracket/casing cover in bronze. (the pumps are supplied fully painted).

Connections: Flanges according to PN 10, EN 1092-2.

Counter-flanges (on request)

Sizes	Flanges
from NM 32/.. to NM 50/...	Screwed flanges EN 1092-1, PN 16
from NM 65/.. to NMS 100/250	Flanges for welding EN 1092-1, PN 10

Applications

- For clean liquids without abrasives, which are non-aggressive for the pump materials (solids content up to 0,2%).
- For water supply.
- For heating, air conditioning, cooling and circulation plants.
- For civil and industrial applications.
- For fire fighting applications. - For irrigation.

Operating conditions

Liquid temperature from -10 °C to +90 °C.

Ambient temperature up to 40° C.

Total suction lift up to 7 m.

Maximum permissible working pressure up to 10 bar.

Continuous duty.

Motor

2-pole induction motor, 50 Hz (n ≈ 2900 rpm).

NM, NMS: three-phase 230/400 V ± 10% up to 3 kW;

400/690 V ± 10% from 4 to 75 kW.

Insulation class F. Protection IP 54.

Classification scheme IE2 for three-phase motor from 0,75 kW.

Constructed in accordance with: EN 60034-1; EN 60034-30.

Special features on request

- Other voltages. - Frequency 60 Hz (as per 60 Hz data sheet).
- Protection IP 55.- Special mechanical seal.
- Packed gland (only for NM standard construction).
- Single-phase motor (NMM) up to 1,5 kW.
- Explosion proof construction in accordance with Directive 94/9 EEC (ATEX).
- Higher or lower liquid or ambient temperatures.

Materials

Components	NM, NMS	B-NM, B-NMS
Pump casing	Cast iron	Bronze
Lantern bracket NM	GJL 200 EN 1561	G-Cu Sn 10 EN 1982
Casing cover for NMS	Cast iron GJL 200 EN 1561	
Lantern bracket NMS	Cast iron GJL 200 EN 1561	
Impeller	Cast iron	Bronze
	GJL 200 EN 1561	G-Cu Sn 10 EN 1982
	Brass P- Cu Zn 40 Pb 2 UNI 5705 for NM 32/12-16-20, NM 40/20, B-NM 32/125-160-200, B-NM 40/200	
Shaft	AISI 303 up to 2.2 kW	Cr Ni Mo steel
	AISI 430 from 3 kW to 75 kW	AISI 316
Mechanical seal	Carbon - Ceramic - NBR	
Counter-flanges	Steel Fe 430B UNI 7070	

Coverage chart n ≈ 2900 rpm

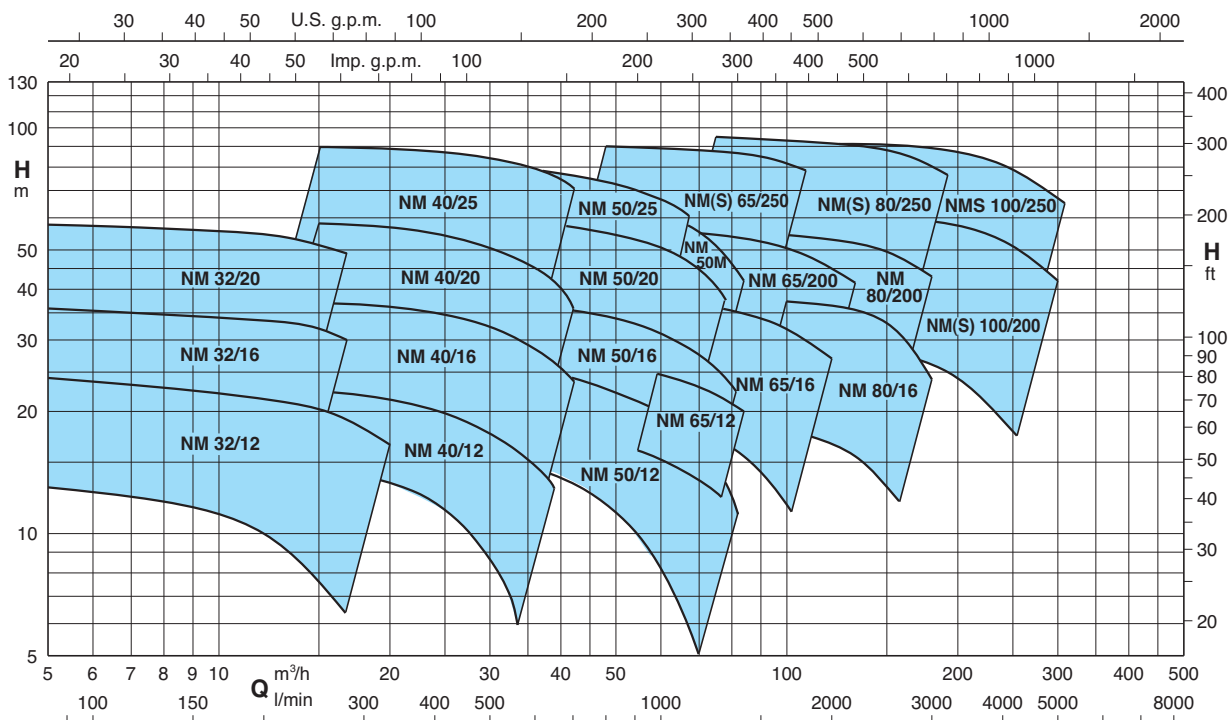

Performance n ≈ 2900 rpm

B-NM	NM	P ₂		Q m ³ /h l/min	6,6	7,5	8,4	9,6	10,8	12	13,2	15	16,8	18,9	21	24	27	30		
		kW	HP		H _m															
					110	125	140	160	180	200	220	250	280	315	350	400	450	500		
B-NM 32/12F	NM 32/12FE	0,55	0,75	H _m	12,5	12,5	12	11,5	11	10	9	7,5								
B-NM 32/12D	NM 32/12DE	0,75	1		18	18	17,5	17	16,5	16	15,5	14								
B-NM 32/12A	NM 32/12AE	1,1	1,5		23	23	22,5	22	21,5	21	20,5	19								
B-NM 32/12S	NM 32/12SE	1,5	2		23,5	23,5	23	22,5	22	21,5	21	20,5								
B-NM 32/16B	NM 32/16BE	1,5	2		29,5	29,5	29	28,5	27,5	27	26	25*	19*	18,5*	16,5*	13*				
B-NM 32/16A/A	NM 32/16A/A	2,2	3		35,5	35,5	35	34,5	34	33,5	33	32*	30*							
B-NM 32/20D/A	NM 32/20D/A	2,2	3		38	37,5	37	36	35	33,5	32									
B-NM 32/20C/A	NM 32/20C/A	3	4		45	44,5	44	43,5	42,5	41	40	38	36*							
B-NM 32/20A/A	NM 32/20A/A	4	5,5		57,5	57	56	55,5	55	54,5	53,5	51,5	49*							

B-NM	NM	P ₂		Q m ³ /h l/min	15	16,8	18,9	21	24	27	30	33	37,8	39	42	45	48	54		
		kW	HP		H _m															
					250	280	315	350	400	450	500	550	630	650	700	750	800	900		
B-NM 40/12F	NM 40/12F/A	1,1	1,5	H _m	14	13,5	13	12	11	9,5	8	6								
B-NM 40/12C	NM 40/12C/A	1,5	2		17,5	17	16,5	16	15	13,5	12	10,5	7,5	6,5						
B-NM 40/12A/A	NM 40/12A/B	2,2	3		22	22	21,5	21	20	19	18	16,5	14	13	11,5					
B-NM 40/16C/A	NM 40/16C/B	2,2	3		23	22,5	22	21,5	20	18,5	16,5	14,5	11	10						
B-NM 40/16B/A	NM 40/16B/B	3	4		29	28,8	28	27,5	26,5	25	23,5	21,5	18	17	14					
B-NM 40/16A/A	NM 40/16A/B	4	5,5		37	36,5	36,5	36	35	33,5	32	30,5	27	26	23,5	20	17			
B-NM 40/20D/A	NM 40/20D/A	4	5,5		39	38	37	35,5	33,5	30,5	27	22,5	14							
B-NM 40/20C/A	NM 40/20C/A	4	5,5		41,5	40,5	39,5	38	36	33,5										
B-NM 40/200B/A	NM 40/200B/A	5,5	7,5		50	49,5	48,5	47,5	45,5	43,5	41,5	37,5	30,5							
	NM 40/20AR/A	5,5	7,5		55	54,5	54	53	51	49										
B-NM 40/200A/A	NM 40/20A/A	7,5	10		57,5	57	56,5	55,5	54,5	52,5	50,5	48	42,5	40,5	35					
B-NM 4025/C/B	NM 40/25C/B	9,2	12,5		61	61	60,5	59,5	58,5	56,5	53,5	49,5	41,5	40	33,5					
B-NM 4025/B/B	NM 40/25B/B	11	15		69,5	69,5	69	68,5	67	65,5	63,5	60,5	53,5	51	45					
B-NM 4025A/B	NM 40/25A/B	15	20		90	90	89,5	89	88,5	87	85	83	77,5	76	70,5					

B-NM	NM	P ₂		Q m ³ /h l/min	24	27	30	33	37,8	42	48	54	60	66	69	72	75	78	81	84			
		kW	HP		H _m																		
					400	450	500	550	630	700	800	900	1000	1100	1150	1200	1250	1300	1350	1400			
B-NM 50/12F/A	NM 50/12F/B	2,2	3	H _m			15,5	15	14	13,5	12	10	8	6									
B-NM 50/12D/A	NM 50/12D/B	3	4				20	19,5	18,5	18	16,5	14,5	13	10,5	9	8							
B-NM 50/12A/A	NM 50/12A/B	4	5,5				24	24	23	22,5	21	19,5	17,5	15	14	12,5	11,5	10					
B-NM 50/12S/A	NM 50/12S/B	4	5,5				26,5	26	25,5	24,5	23,5	22	20	18	16,5	15,5	14	13	11				
B-NM 50/160B/B	NM 50/16B/B	5,5	7,5				31	30,5	29,5	28	26	24	21,5	19	17,5	15,5	13,5	11,5	9,5				
B-NM 50/160A/B	NM 50/16A/B	7,5	10				38,5	38	37,5	36,5	34,5	32,5	30	27	25,5	24	22,5	20,5	19				
B-NM 50/200B/B	NM 50/20B/B	9,2	12,5		48	47,5	47,5	47	45,5	44,5	42,5	40	37	33	30,5	28	25,5	23					
B-NM 50/200A/B	NM 50/20A/B	11	15		55	55	54,5	54,5	53,5	52	50	48	45	41,5	39,5	37	35	32,5					
B-NM 50/200S/B	NM 50/20S/B	15	20		60	60	59,5	59,5	58,5	57,5	55,5	53,5	50,5	47	45	43	40,5	37					
B-NM 5025/C/B	NM 50/25C/B	11	15		55	54,5	54	53	51,5	49,5	46	41,5	35,5	28,5	24,5								
B-NM 5025/B/B	NM 50/25B/B	15	20		69	68,5	68	67,5	66	64	61	57	52,5	46,5	43								
B-NM 5025A/B	NM 50/25A/B	18,5	25		80,5	80,5	80	79,5	78,5	77	74,5	71,5	67	61,5	58,5								
B-NM 5025/65E/A	NM 50M/E/A	11	15				48	47,5	47	46	45	43	40	37	32	29,5	27	24					
B-NM 5025/65D/A	NM 50M/D/A	15	20				57	56,5	56	55	53	51	48	44,5	42	39,5	37	32	29	25*			
B-NM 5025/65C/A	NM 50M/C/A	18,5	25				68	67,5	67	66,5	65	63	61	58	56	53,5	51,5	48	45,5	42*			

B-NM - B-NMS	NM - NMS	P ₂		Q m ³ /h l/min	37,8	42	48	54	60	66	75	84	96	108	120	132	150	168		
		kW	HP		H _m															
					630	700	800	900	1000	1100	1250	1400	1600	1800	2000	2200	2500	2800		
	NM 65/12E/A	4	5,5	H _m	18	17,5	17	16,5	16	15	13,5*									
B-NM 65/125C/A	NM 65/12C/A	5,5	7,5		22	21,5	21	20,5	20	19,5	18	15,5*								
B-NM 65/125A/A	NM 65/12A/A	7,5	10		26	25,5	25	24,5	24	23,5	22	20*								
B-NM 65/160E/A	NM 65/16E/A	5,5	7,5				20	19,5	19	18,5	17	15,5	13*	10*						
B-NM 65/160D/A	NM 65/16D/A	7,5	10				26	25,5	25	24,5	23,5	22	20*	16,5*	13*					
B-NM 65/160C/A	NM 65/16C/A	9,2	12,5				30	29,5	29	28,5	28	26,5	24,5*	21,5*	18*					
B-NM 65/160B/A	NM 65/16B/A	11	15				33,5	33	32,5	32	31	30	28*	25,5*	22*					
B-NM 65/160A/A	NM 65/16A/A	15	20				38	37,5	37	36,5	36	35	33*	30,5*	27*					
B-NM 65/200C/A	NM 65/20C/A	15	20				44	43,5	43	42,5	41	39,5	37,5*	35*	31*	27*				
B-NM 65/200B/A	NM 65/20B/A	18,5	25				50	49,5	49	48,5	47,5	46,5	44,5*	42*	39*	35*				
B-NM 65/200A/A	NM 65/200A/A	22	30				56,5	56	55,5	55	54,5	53,5	51*	48,5*	45,5*	41,5*				
B-NM 65/250C/A	NM 65/250C/A	22	30				64	63,5	63	61,5*	60*	57,5*	54,5*	50*						
B-NM 65/250B/A	NM 65/250B/A	30	40				79,5	79	78,5	78*	77*	75*	72*	67*						
B-NMS 65/250A	NMS 65/250A	37	50				90	89,5	89	88,5*	87,5*	86*	83,5*	78,5*						

Performance n ≈ 2900 rpm

B-NM - B-NMS	NM - NMS	P ₂		Q m ³ /h l/min	75	84	96	108	120	132	150	168	180	192	210	240	270	300
		kW	HP															
B-NM 80/160E/A	NM 80/16E/A	7,5	10	20	19,3	18,5	17,5*	16,5*	15,5*	13*								
B-NM 80/160D/A	NM 80/16D/A	9,2	12,5	23	22,5	22	21*	19,5*	18*	15*								
B-NM 80/160C/A	NM 80/16C/A	11	15	27,5	27	26,5	25,5*	24,5*	23*	20*	16*							
B-NM 80/160B/A	NM 80/16B/A	15	20	34	33,5	33	32,5*	32*	31*	28*	23*	18*						
B-NM 80/160A/A	NM 80/16A/A	18,5	25	38,5	38	37,5	37*	36,5*	36*	33*	29*	24*						
B-NMS 80/200B	NM 80/200B/A	22	30	46,5	46	45,5	44,5	43,5*	42*	39*	35,5*	32*						
B-NMS 80/200A	NM 80/200A/A	30	40	56	55,5	55	54	53*	52*	49,5*	46*	43*						
B-NMS 80/250E	NM 80/250E/A	22	30	51	50	48,5	46,5	44,5*	42*	38*	33*	29*						
B-NMS 80/250D	NM 80/250D/A	30	40	65	64	62,5	61	59*	56,5*	53*	49*	45,5*	41*					
B-NMS 80/250C	NMS 80/250C	37	50	73,5	73	72	70,5	69*	67*	63*	59*	55,5*	51,5*					
B-NMS 80/250B	NMS 80/250B	45	60	84	83,5	82,5	81,5	80*	78*	74,5*	70,5*	67*	63*					
B-NMS 80/250A	NMS 80/250A	55	75	95	94,5	93,5	92,5	91,5*	90*	87,5*	84*	80,5*	76,5*					
B-NMS 100/200E	NM 100/200E/A	18,5	25				30	29,5	29	28	27	26*	25*	23*	19*			
B-NMS 100/200D	NM 100/200D/A	22	30				36	35,5	35	34	33	32*	31*	29*	24,5*	19*		
B-NMS 100/200C	NM 100/200C/A	30	40				45	44,5	44	43,5	42,5	41,5*	40,5*	39*	34,5*	29*		
B-NMS 100/200B	NMS 100/200B	37	50				54	53,5	53	52,5	51,5	50,5*	49,5*	48*	44*	38,5*	32°	
B-NMS 100/200A	NMS 100/200A	45	60				61,5	61	60,5	60	59,5	58,5*	58*	56,5*	53*	48*	42°	
B-NMS 100/250B	NMS 100/250B	55	75				73,5	73	72,5	71,5	70	68,5*	67*	65*	61*	55,5*	48,5°	
B-NMS 100/250A	NMS 100/250A	75	100				91	90,5	90	89,5	88,5	88*	87*	85*	81*	75*	67°	

NM(S) Standard construction.
B-NM(S) Bronze construction.

P₂ Rated motor power output.
H Total head in m.

* Maximum suction lift 1-2 m.
◦ With 1 m suction head.

Tolerances according to ISO 9906, annex A.

Rated currents

P ₂		230V Δ / 400V Y 400V Δ / 690V Y			I _A /I _N
kW	HP	I _N A	I _N A	I _N A	
0,55	0,75	3	1,7		4,3
0,75	1	3,3	1,9		5,8
1,1	1,5	4,7	2,7		5,6
1,5	2	7,5	4,3		5,5
2,2	3	9,2	5,3		7,4
3	4	11,5	6,6		8,2
4	5,5		9,6	5,5	7,6
5,5	7,5		10,9	6,3	9,1
7,5	10		14,3	8,3	9,1
9,2	12,5		18,5	10,7	8,2
11	15		21,5	12,4	8,5
15	20		27,3	15,8	9,5
18,5	25		34	19,6	9,4
22	30		41	23,7	10,7
30	40		54	31,2	8,8
37	50		64	36,9	7,2
45	60		77	44,5	7,3
55	75		93	53,7	6,8
75	100		128	73,9	7

P₂ Rated motor power output.
I_A/I_N D.O.L. starting current / Nominal current

Characteristic curves $n \approx 2900$ rpm

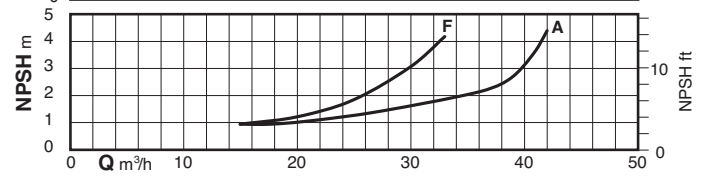
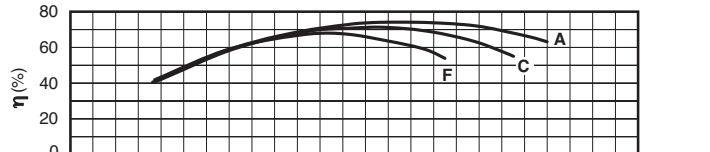
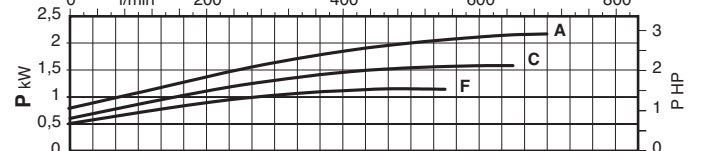
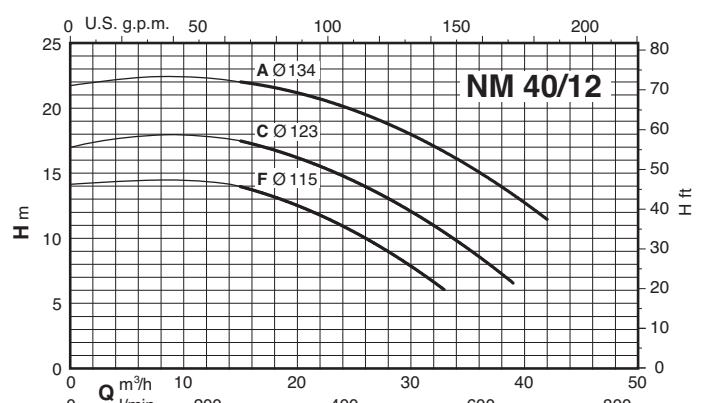
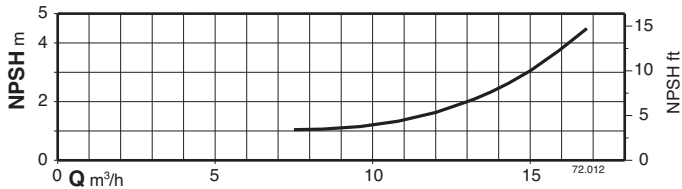
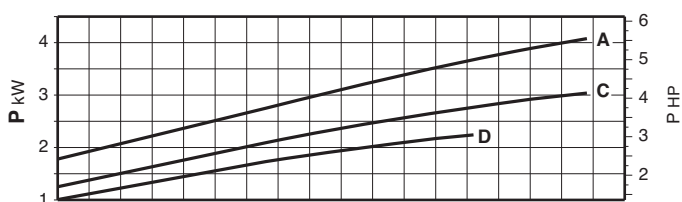
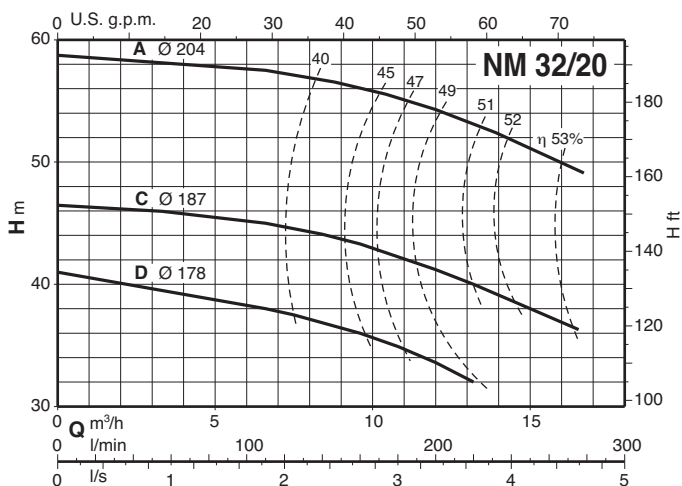
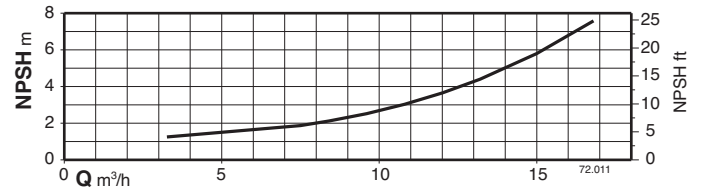
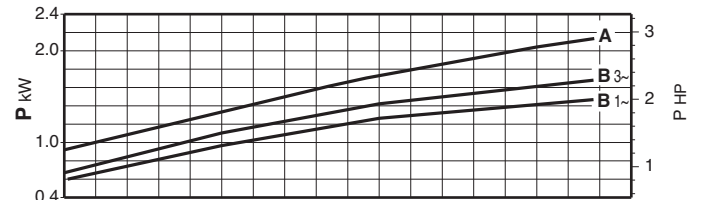
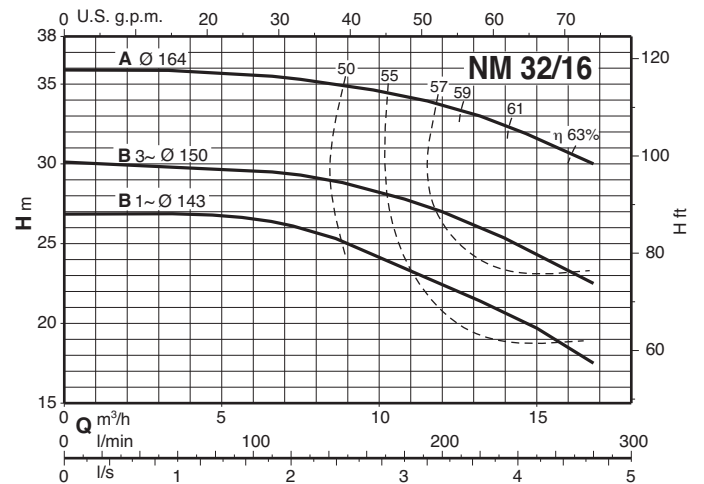
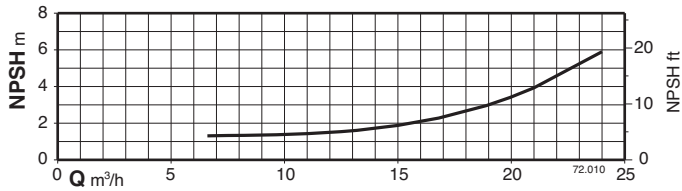
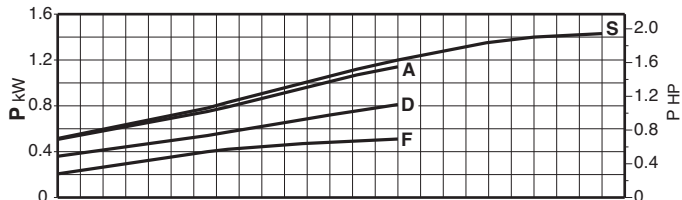
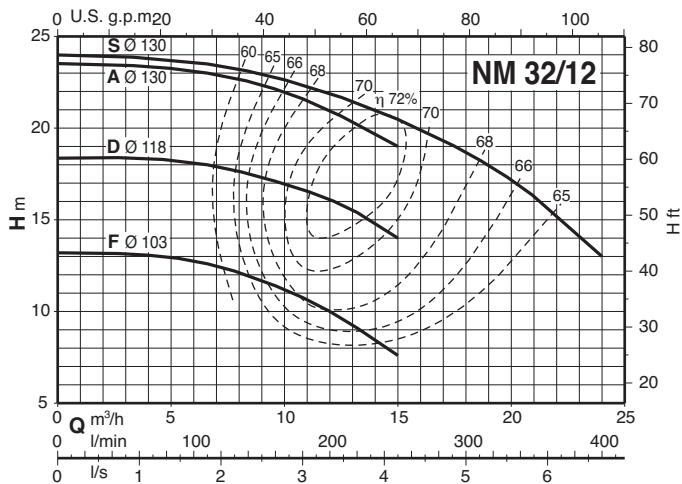

Characteristic curves $n \approx 2900$ rpm

2

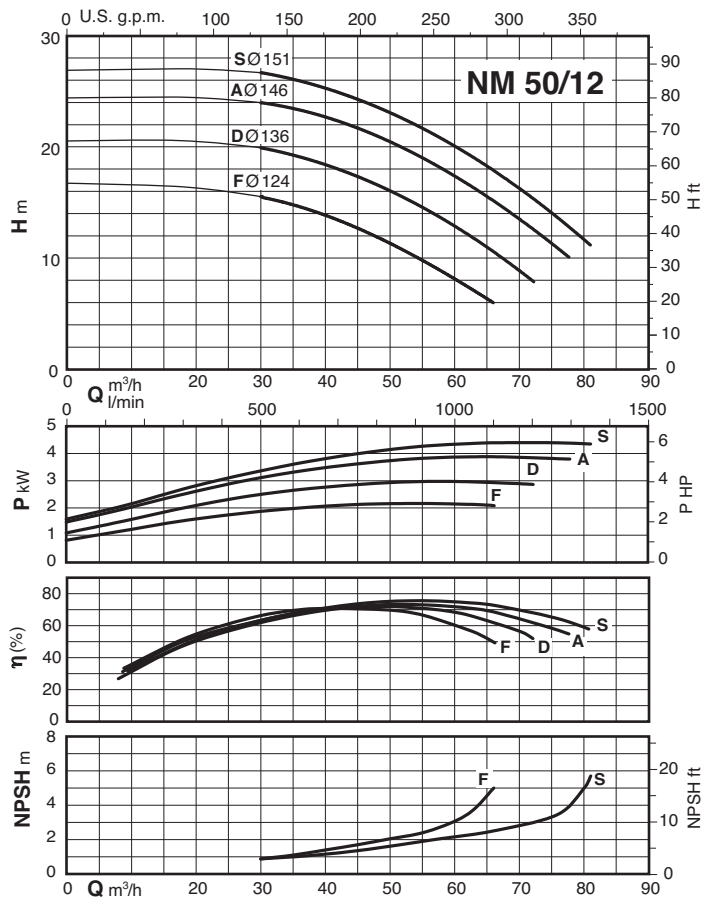
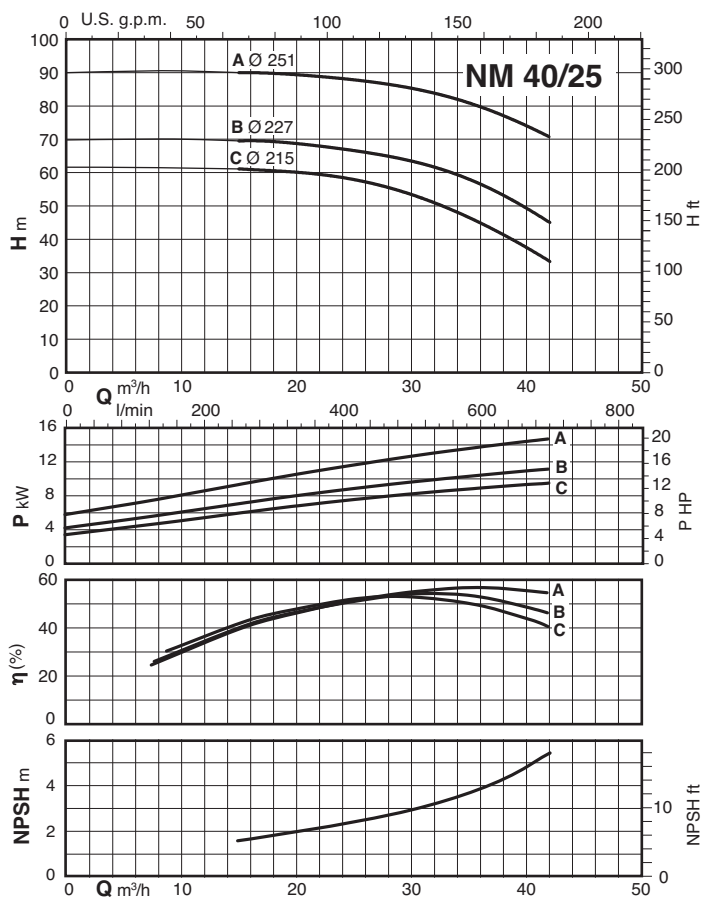
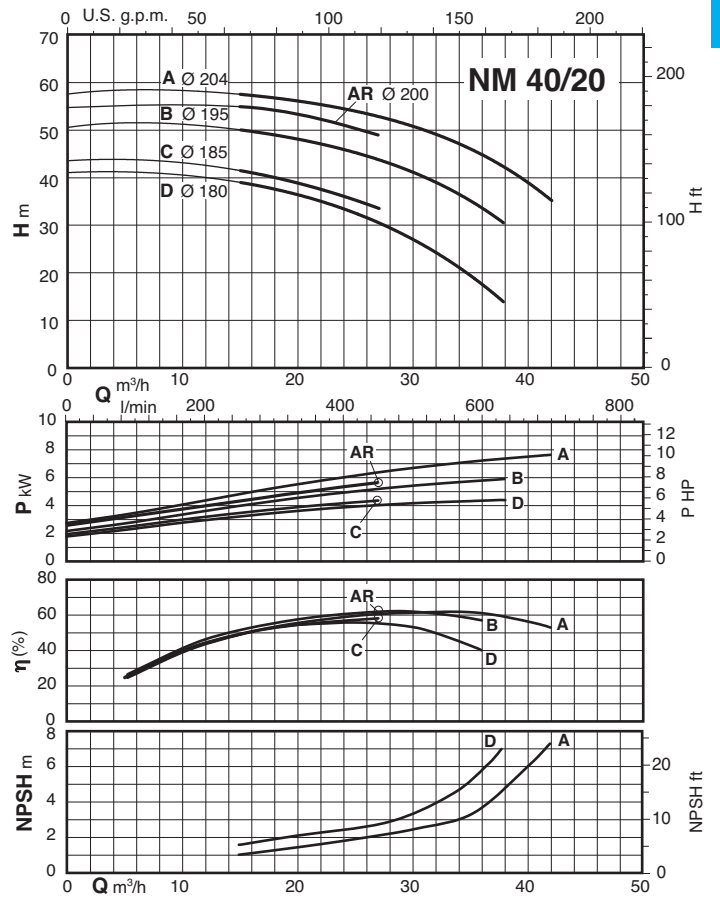
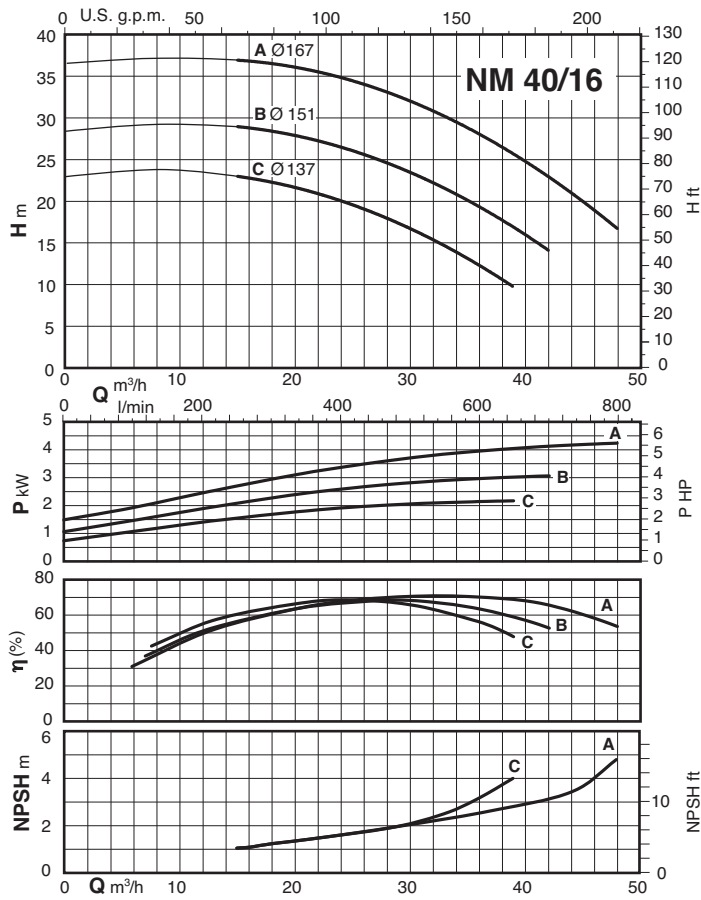

Characteristic curves $n \approx 2900$ rpm

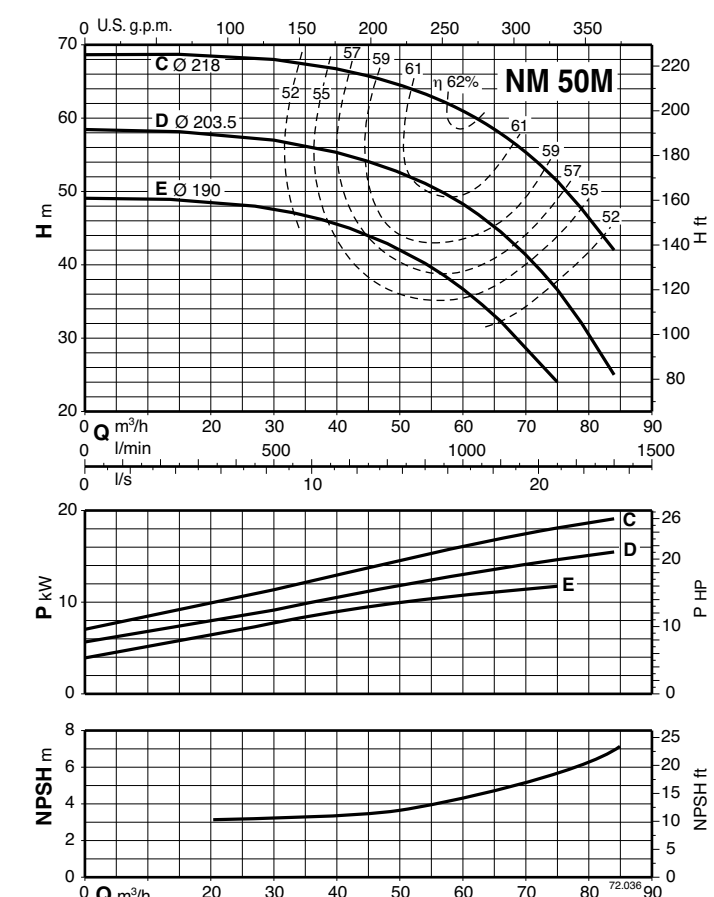
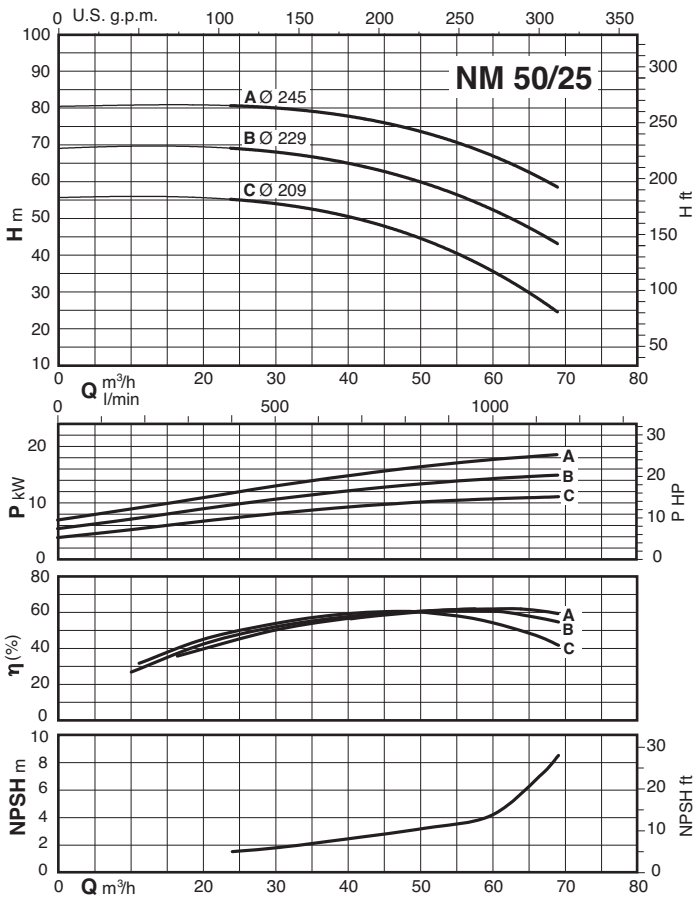
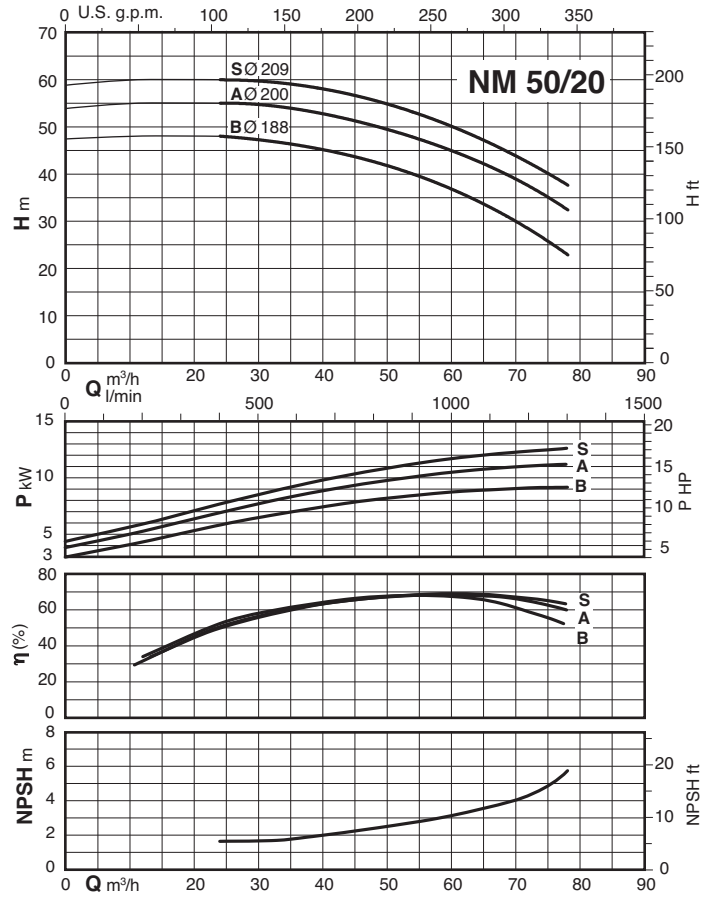
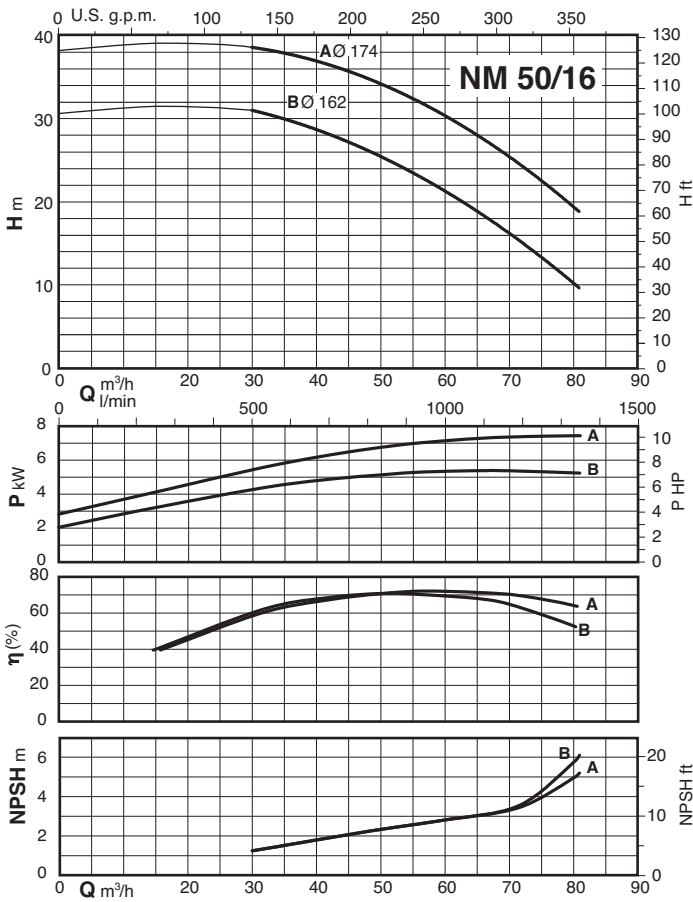

Characteristic curves $n \approx 2900$ rpm

2

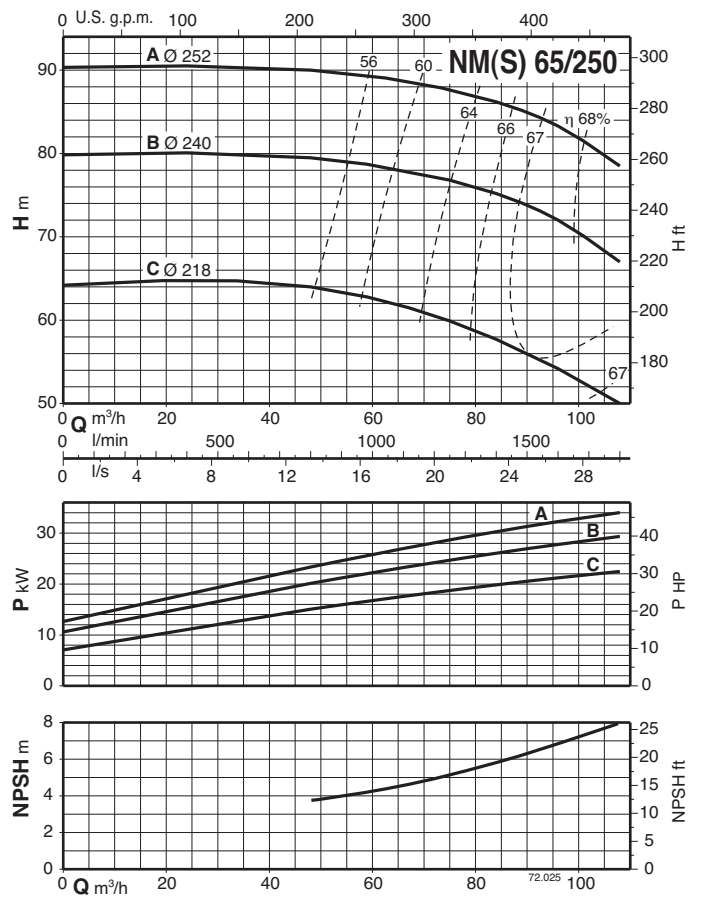
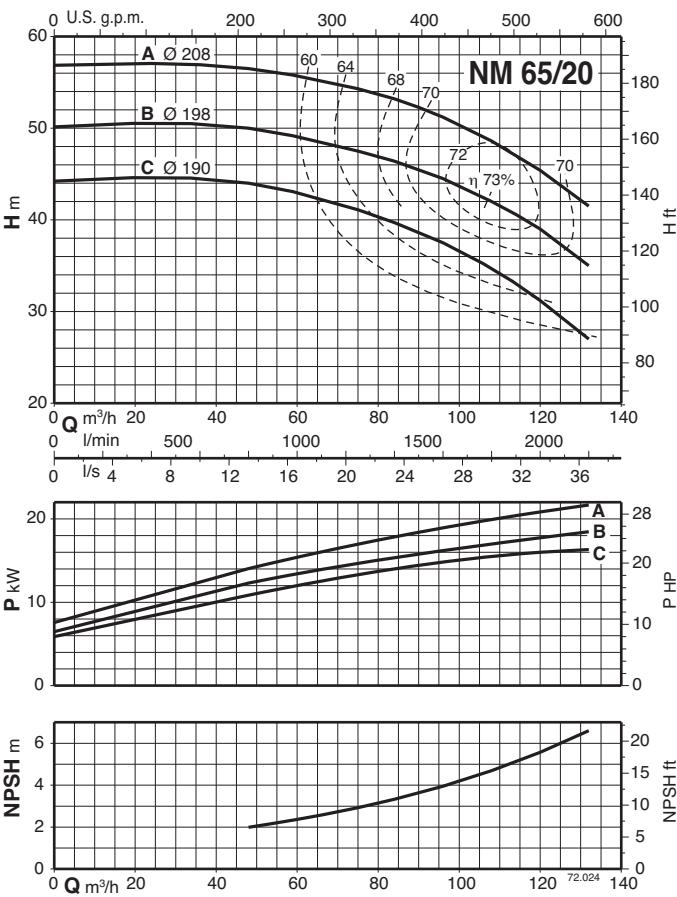
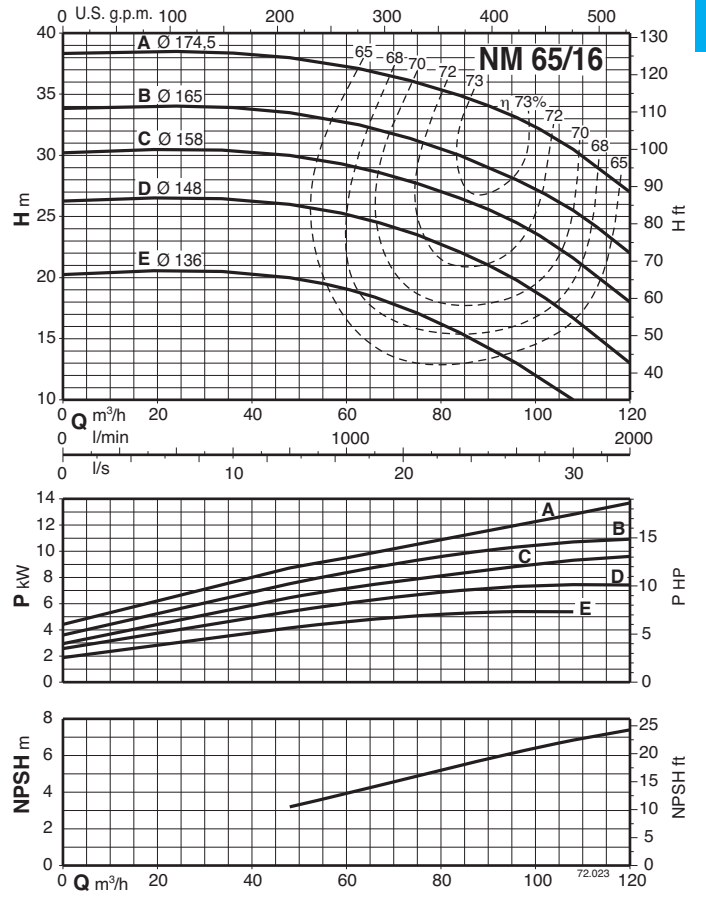
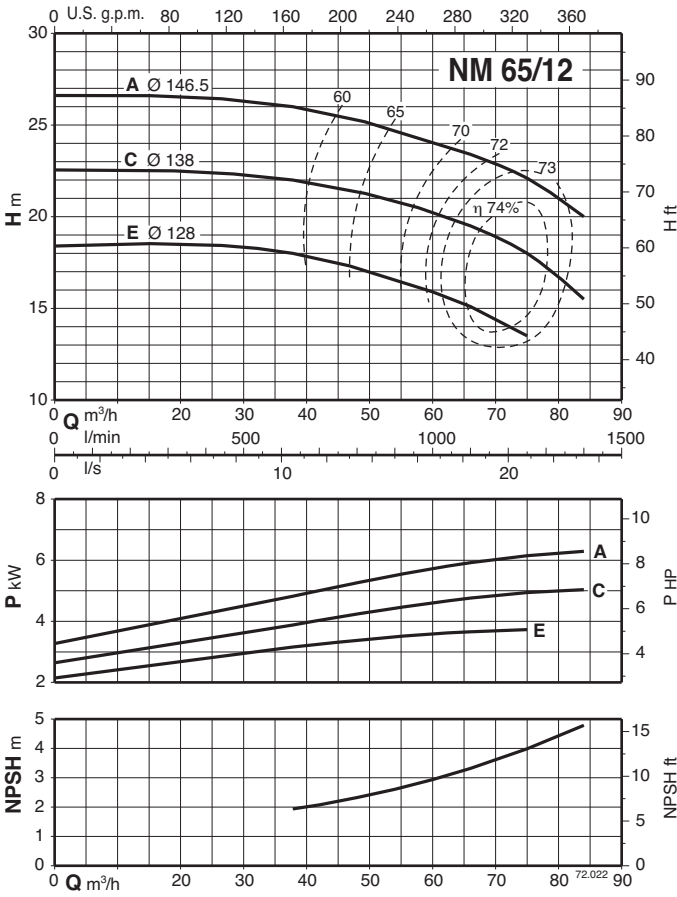

Characteristic curves $n \approx 2900$ rpm

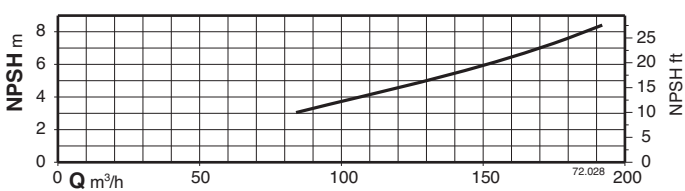
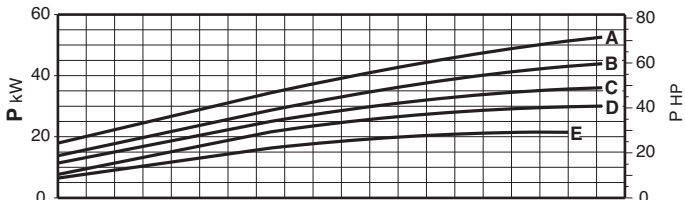
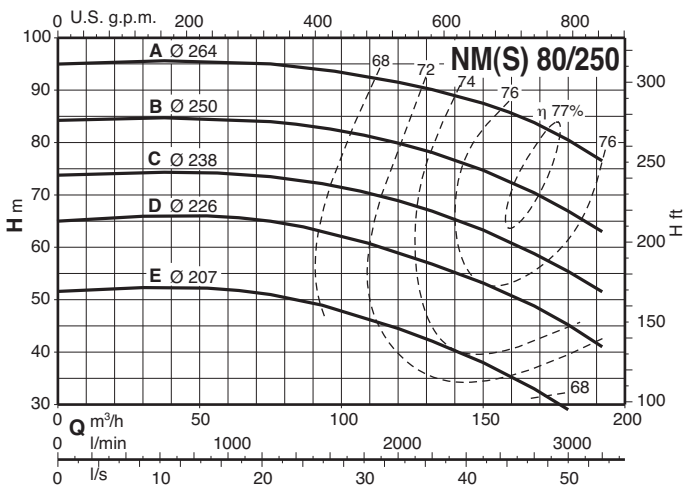
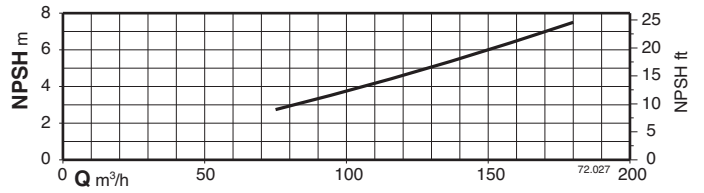
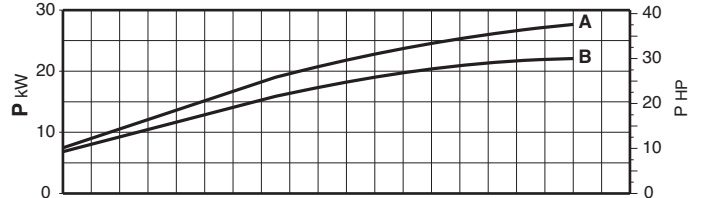
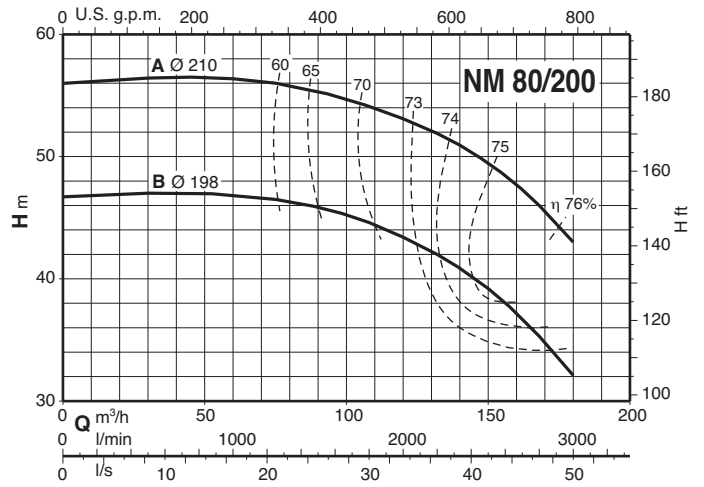
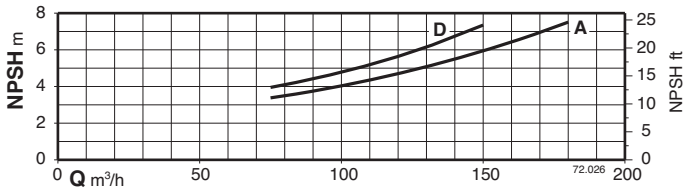
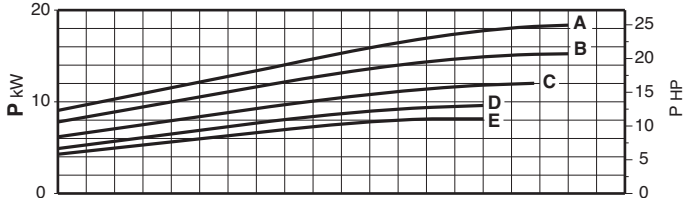
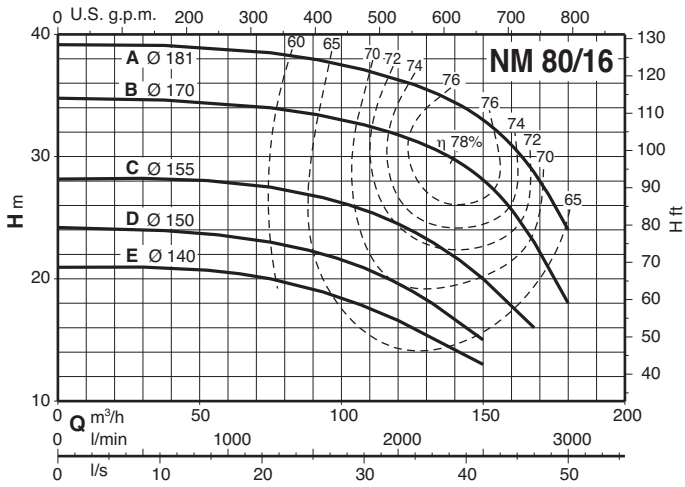

Characteristic curves $n \approx 2900$ rpm

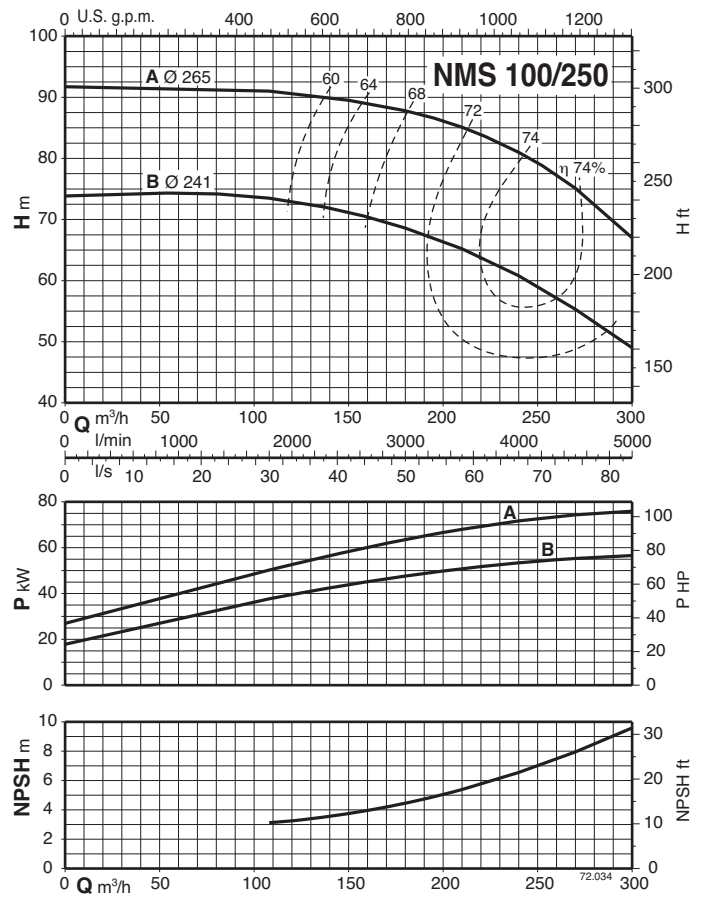
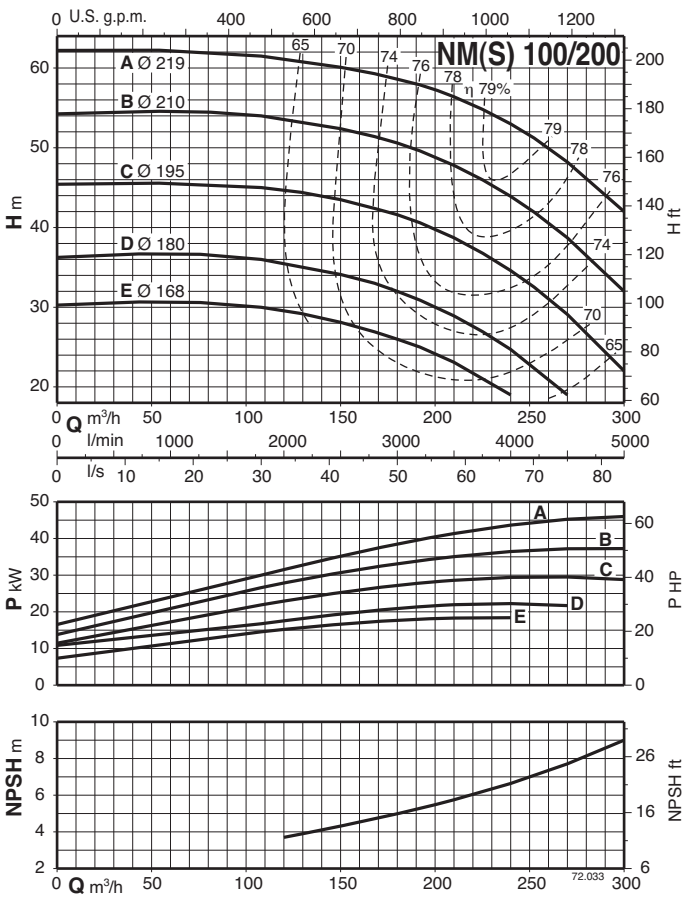

Dimensions and weights

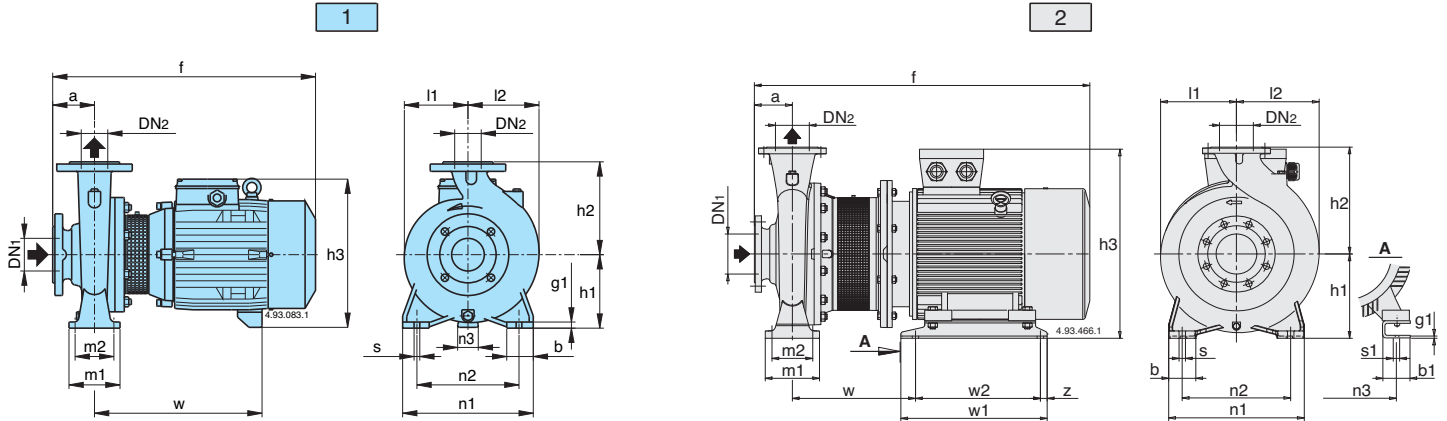

Picture	NM	mm																			kg	
		DN1	DN2	a	f	h1	h2	h3	m1	m2	n1	n2	n3	z	b	s	l1	l2	w	g1		
1	NM 32/12SE-AE-DE-FE	50	32	80	405	112	140	240	100	70	190	140	37	-	50	14	93	97	245	12	27-25-24-24	
	NM 32/16BE NM 32/16A/A	50	32	80	410 450	132	160	260	100	70	240	190	47	-	50	14	120	120	250 290	12	34 39	
	NM 32/20D/A NM 32/20C/A NM 32/20A/A	50	32	80	450 475 475	160	180	288 298 298	100	70	240	190	62 60 60	-	50	14	140	140	290 295 295	12	42 52 52,5	
	NM 40/12C/A-F/A NM 40/12A/B	65	40	80	410 450	112	140	240	100	70	210	160	37	-	50	14	100	113	250 290	12	29-27 34	
	NM 40/16C/B NM 40/16B/B NM 40/16A/B	65	40	80	450 475 475	132	160	260 270 270	100	70	240	190	47 45 45	-	50	14	119	119	290 295 295	12	39 48 49,5	
	NM 40/20C/A-D/A NM 40/20A/A-AR/A-B/A	65	40	100	495 525	160	180	298 320	100	70	265	212	60 49	-	50	14	140	140	295 320	12	55,5-55,5 72,5-66-66	
	NM 40/25B/B-C/B NM 40/25A/B	65	40	100	640 715	180	225	365	125	95	320	250	50	-	65	14	175	175	410 460	15	116-110 145,5	
	NM 50/12F/B NM 50/12D/B NM 50/12A/B-S/B	65	50	100	470 495 495	132	160	260 270 270	100	70	240	190	47 45 45	-	50	14	121	137	290 295 295	12	41 50 51,5-51,5	
	NM 50/16A/B-B/B	65	50	100	525	160	180	320	100	70	265	212	49	-	50	14	127	141	320	14	70,5-64	
	NM 50/20A/B-B/B NM 50/20S/B	65	50	100	640 720	160	200	345	100	70	265	212	40	-	50	14	140	153	410 460	15	106-100 124,5	
	NM 50/25C/B NM 50/25B/B NM 50/25A/B	65	50	100	645 720 720	180	225	365	125	95	320	250	50	-	65	14	175	175	415 465 465	15	126 144,5 153	
	NM 50M/E/A NM 50M/D/A NM 50M/C/A	65	50	100	700 750 775	192	225	377	298	258	262	216	-	20	69	12	175	175	239	6*	135 151 165	
	NM 65/12E/A NM 65/12A/A-C/A	80	65	100	495 525	160	180	298 320	125	95	280	212	60 49	-	65	14	134	156	295 320	15	55,5 73,5-68	
	NM 65/16D/A-E/A NM 65/16B/A-C/A NM 65/16A/A	80	65	100	525 640 715	160	200	320 345 345	125	95	280	212	49 40 40	-	65	14	150	172	320 410 460	15	75-70 106-100 133,5	
	NM 65/20C/A NM 65/20B/A	80	65	100	715	180	225	365	125	95	320	250	50	-	65	14	155	175	460	15	139,5 145	
	4	NM 65/200A/A	80	65	100	825	202	225	408	400	360	344	254	-	20	90	14	155	175	245	42*	185
		NM 65/250B/A-C/A	80	65	100	825	202	250	408	400	360	344	254	-	20	90	14	175	190	245	42*	201-195
	1	NM 80/16E/A NM 80/16C/A-D/A NM 80/16B/A NM 80/16A/A	100	80	125	545 670 745 745	180	225	340 365 365 365	125	95	320	250	60 50 50 50	-	65	14	165	193	320 415 465 465	15	83,5 113-108 142,5 150
		NM 80/200A/A-B/A	100	80	125	850	202	250	408	400	360	344	254	-	20	90	14	170	194	245	42*	200-194
		NM 80/250D/A-E/A	100	80	125	850	202	280	408	400	360	344	254	-	20	90	14	191	210	245	42*	209-203
NM 100/200E/A NM 100/200C/A-D/A		125	100	125	800 850	192 202	280	377 408	298 400	258 360	262 344	216 254	-	20	69 90	12 14	180	212	239 245	6 42*	179 201-195	

Flanges EN 1092-2

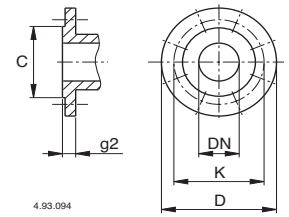

DN	mm				
	C	K	D	Holes N° Ø	g2
32	76	100	140	4 19	18
40	84	110	150	4 19	18
50	99	125	165	4 19	20
65	118	145	185	4 19	20
80	132	160	200	8 19	22
100	156	180	220	8 19	24
125	184	210	250	8 19	24

Picture	NMS	mm																				kg		
		DN1	DN2	a	f1	f	h1	h2	h3	m1	m2	n1	n2	n3	b	b1	s	s1	l1	l2	w		w1	w2
2	NMS 65/250A	80	65	100	373	1032	200	250	505	160	120	360	280	318	80	83	18	19	175	190	406	355	305	
	NMS 80/250C	100	80	125	398	1057	200	280	505	160	120	400	315	318	80	83	18	19	200	210	406	355	305	
	NMS 80/250B	100	80	125	421	1130	225	280	550	160	120	410	315	356	80	80	18	19	225	225	445	361	286	
	NMS 80/250A	100	80	125	451	1198	250	280	642	160	120	410	315	406	80	100	18	24	275	275	619	409	349	
	NMS 100/200B	125	100	125	398	1057	200	280	505	160	120	360	280	318	80	83	18	19	200	212	406	355	305	
	NMS 100/200A	125	100	125	421	1130	250	280	550	160	120	410	315	356	80	80	18	19	225	225	445	361	286	
	NMS 100/250B	125	100	125	466	1213	250	280	642	160	120	410	315	406	80	100	18	24	275	275	494	409	349	
	NMS 100/250A	125	100	125	466	1286	280	280	712	160	120	410	315	457	80	100	18	24	275	275	516	479	368	

Pumps with packed gland, dimensions available on request.

Dimensions and weights

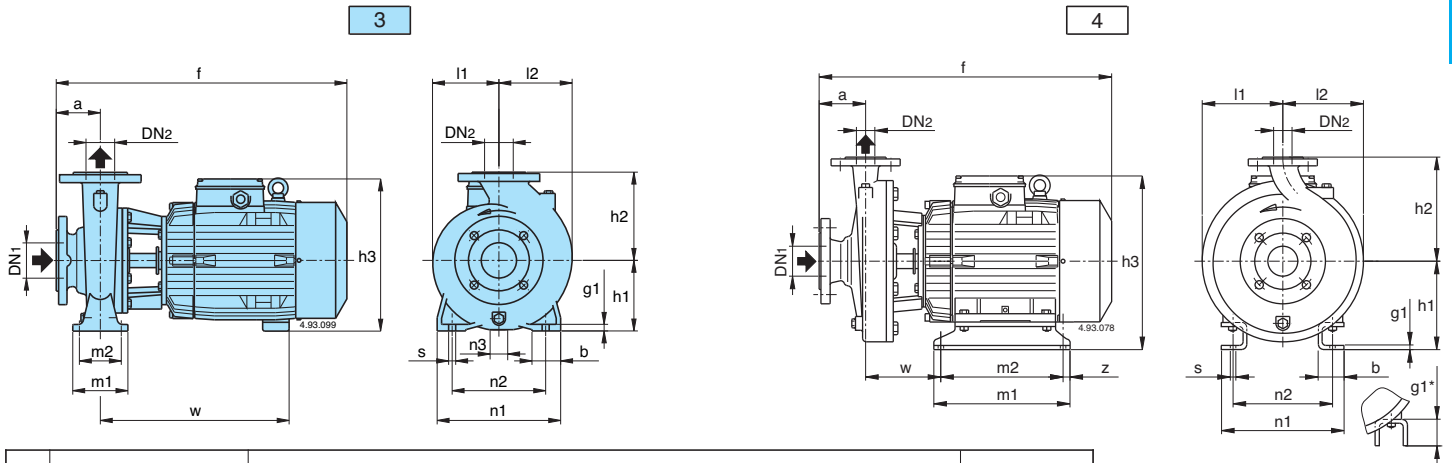

Picture	B- NM	mm																	kg		
		DN1	DN2	a	f	h1	h2	h3	m1	m2	n1	n2	n3	z	b	s	l1	l2	w	g1	B-NM
1	B-NM 32/12S-A-D-F	50	32	80	405	112	140	240	100	70	190	140	37	-	50	14	93	97	245	12	33-32-31-29
	B-NM 32/16B	50	32	80	410	132	160	260	100	70	240	190	47	-	50	14	120	120	250	12	44
	B-NM 32/16A/A				450														290		48
	B-NM 32/20D/A	50	32	80	450	160	180	298	100	70	240	190	60	-	50	14	140	140	290	12	52
	B-NM 32/20C/A				475														295		60
	B-NM 32/20A/A				475														298		60
B-NM 40/12C-F	65	40	80	410	112	140	240	100	70	210	160	37	-	50	14	100	113	250	12	35-33	
B-NM 40/12A/A				450														290		40	
B-NM 40/16C/A	65	40	80	450	132	160	270	100	70	240	190	45	-	50	14	119	119	290	12	48	
B-NM 40/16B/A				475														295		56	
B-NM 40/16A/A				475														295		57,5	
B-NM 40/20C/A-D/A	65	40	100	495	160	180	298	100	70	265	212	60	-	50	14	140	140	295	12	63,5-62,5	
B-NM 40/200A/A-B/A				580														320		49	375
B-NM 4025/B/B-C/B	65	40	100	635	192	225	377	298	258	262	216	-	20	69	12	175	175	174	6	130-124	
B-NM 4025/A/B				705														20		159,5	
B-NM 50/12F/A	65	50	100	470	132	160	270	100	70	240	190	45	-	50	14	121	137	290	12	52	
B-NM 50/12D/A				495														295		61	
B-NM 50/12A/A-S/A				495														295		63,5-63,5	
B-NM 50/160A/B-B/B	65	50	100	580	160	180	320	100	70	265	212	49	-	50	14	127	141	375	14	80,5-74,5	
B-NM 50/200A/B-B/B	65	50	100	695	192	200	377	298	258	262	216	-	20	69	12	140	153	234	6	128-121	
B-NM 50/200S/B				720														140,5			
B-NM 5025/C/B	65	50	100	635	192	225	377	298	258	262	216	-	20	69	12	175	175	174	6	135	
B-NM 5025/B/B				710														144			
B-NM 5025/A/B				710														161			
B-NM 5025/65E/A	65	50	100	635	192	225	377	298	258	262	216	-	20	69	12	175	175	174	6	135	
B-NM 5025/65D/A				710														156,5			
B-NM 5025/65C/A				710														161			
B-NM 65/125A/A-C/A	80	65	100	580	160	180	320	125	95	280	212	49	-	65	14	134	156	375	15	93,5-73	
B-NM 65/160D/A-E/A	80	65	100	575	160	200	320	125	95	280	212	49	-	65	14	150	172	375	15	83,5-79	
B-NM 65/160C/A				660														40		108	
B-NM 65/160B/A	80	65	100	695	192	200	377	298	258	262	216	-	20	69	12	150	172	234	6	149	
B-NM 65/160A/A				770														178,5			
B-NM 65/200B/A-C/A	80	65	100	775	192	225	377	298	258	262	216	-	20	69	12	155	175	239	6	183-169,5	
B-NM 65/200A/A				825														202		200	
B-NM 65/250B/A-C/A	80	65	100	825	202	250	408	400	360	344	254	-	20	90	14	175	190	245	42*	216-210	
B-NM 80/160E/A	100	80	125	605	180	225	340	125	95	320	250	60	-	65	14	165	193	375	15	108,5	
B-NM 80/160D/A				685														50		116	
B-NM 80/160C/A	100	80	125	725	192	225	377	298	258	262	216	-	20	69	12	165	193	239	6	155	
B-NM 80/160B/A				800														175,5			
B-NM 80/160A/A				800														182			

Flanges EN 1092-2

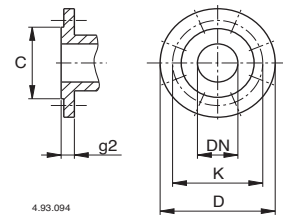

mm						
DN	C	K	D	Holes		g2
				N°	Ø	
32	76	100	140	4	19	18
40	84	110	150	4	19	18
50	99	125	165	4	19	20
65	118	145	185	4	19	20
80	132	160	200	8	19	22
100	156	180	220	8	19	24
125	184	210	250	8	19	24

Picture	B-NMS	mm																			kg									
		DN1	DN2	a	f1	f	h1	h2	h3	m1	m2	n1	n2	n3	z	b	b1	s	s1	l1		l2	w	w1	w2	g1				
2	B-NMS 65/250A	80	65	100	373	1032	200	250	505	160	120	360	280	318	-	80	83	18	19	175	190	406	355	305	-					
	B-NMS 80/200B	100	80	125	398	936	180	250	386	125	95	345	280	254	20	65	60	14	15	170	194	259	350	310	6					
	B-NMS 80/200A	100	80	125	398	936	180	250	386	355	305	388	318	254	20	83	60	19	15	170	194	259	350	310	6					
	B-NMS 80/250D-E	100	80	125	398	936	200	280	406	160	120	400	315	254	20	80	60	18	15	191	210	259	350	310	6					
	B-NMS 80/250C					1057			505					318												19	200	406	305	6
	B-NMS 80/250B	100	80	125	421	1130	225	280	550	260	220	410	315	356	-	80	80	18	19	225	225	445	361	286	-					
	B-NMS 80/250A				451	1198			642					24												275	275	619	409	349
	B-NMS 100/200E	125	100	125	398	857	200	280	411	160	120	360	280	216	20	80	60	18	15	180	212	259	350	310	6					
	B-NMS 100/200C-D					1057			505					318												19	200	406	305	6
	B-NMS 100/200B					1057			505					318												19	200	406	305	6
	B-NMS 100/200A	125	100	125	421	1130	250	280	550	260	220	410	315	356	-	80	80	18	19	225	225	445	361	286	-					
	B-NMS 100/250B	125	100	125	466	1213	250	280	642	260	220	410	315	406	-	80	100	18	24	275	275	494	409	349	-					
B-NMS 100/250A	1286					712			457					100												18	24	275	275	516